

Ondal Pendant Manager in pCon.planner

Content

1. Interesting Facts.....	2
The program interface	2
Work Area and View Window	3
The toolbar - All important tools at your fingertips	3
Working with mouse and keyboard	4
Helpful Links.....	5
2. Working Areas and Presentation.....	6
3. Navigation	7
4. View	7
5. Inserting and configuring Ondal products.....	8
Change positions of Gas Outlets	11
Importing additional objects.....	12
6. Selecting, moving and rotating objects.....	12
Move and rotate objects.....	13
7. Project Information and Drawing Templates	15
8. Create and Export Drawings.....	17
9. Export Article List as Excel Table.....	20
10. Drawings of Walls	20
11. Insert Room and Wall Elements	20
Plan wall elements	20
Extend Floor Plan	22
Draw Floor and Ceiling	22
Dimension floor plan.....	22
12. Import and Edit Footprint	22
13. Render Images and Animations.....	23
14. Share Content	23
15. Export	24

1. Interesting Facts

pCon.planner is a software for planning and visualizing rooms that combines many different tools and functions. In a short time, you will have created a room, fitted it with windows, doors, glass fronts and, of course, the Ondal pendant systems.

This document is intended to help you learn the most important functions of pCon.planner. With a little practice, you will be able to configure our systems, position them in rooms and share the results with your customers in 3D in no time at all. Of course, pCon.planner can also output drawings in various formats.

If you would like to work even more intensively with pCon.planner, our partner EasternGraphics offers comprehensive training courses on special functions (e.g. detailed room design, photorealistic rendering, use of light sources, creation of animations, etc.).

Detailed information on individual functions and video tutorials can be found on this page: [pCon.planner 8 online help \(pcon-planner.com\)](http://pcon-planner.com)

Together with these instructions, you will can find the following files at our website: A pCon.planner file with the name **Operating Room** and a PDF file **Floor_Plan.pdf**. You can use these files to test some of the functions described here. In chapter 7 you will also need the drawing templates **Ondal_DE_EN.dwt**.

The program interface

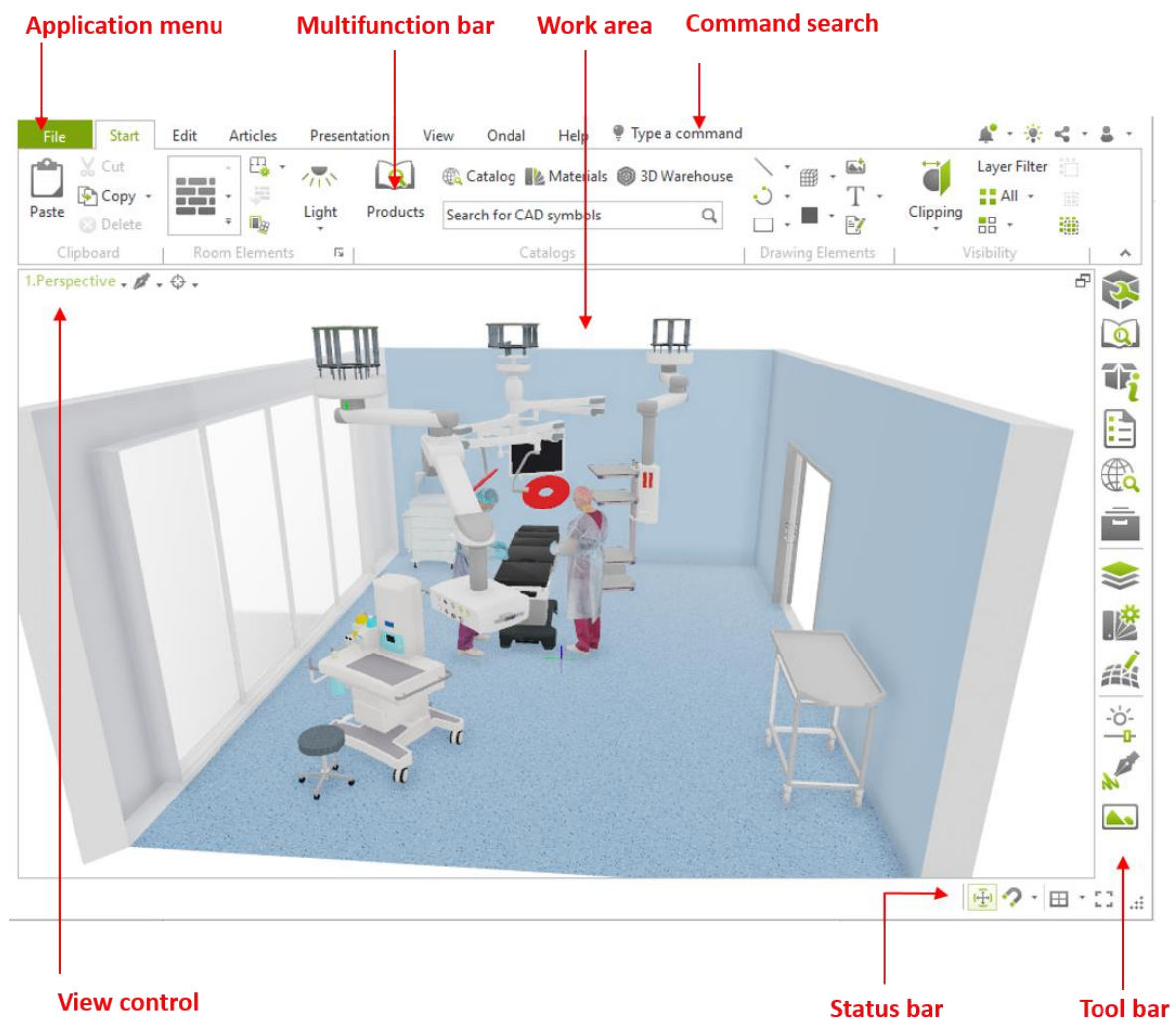

Work Area and View Window

The workspace can be divided into several windows. You can view your planning from different perspectives in these view windows. You can switch freely between the views during your work steps.

You can control the number of view windows via the status bar (bottom right).

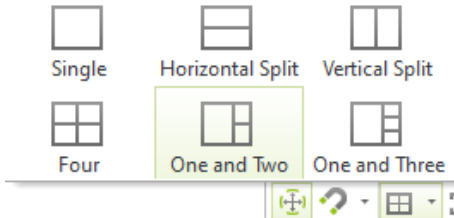



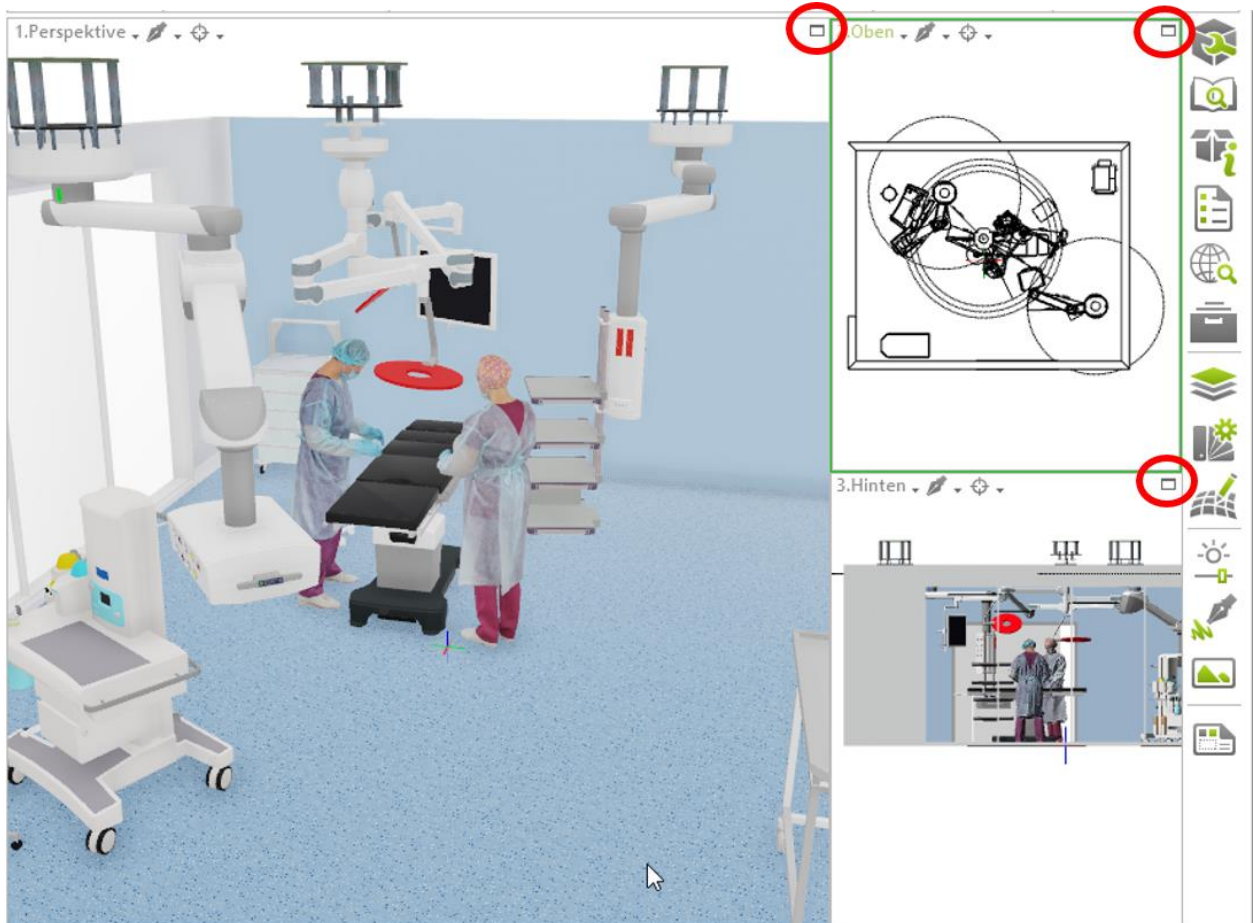





Click on the icon in the top right-hand corner to maximize or minimize each workspace.





The toolbar - All important tools at your fingertips

Icon	Tool	Function
	Properties editor	Call up and change the properties of a selected object
	Product catalogues	Locally installed manufacturer catalogs with OFML articles

	Product Information	Dialog with extended information, inspirations and data sheets for the last selected commercial item
	Article list	Create a list of configurable articles in planning
	pCon.catalog	Web catalogs with high-quality 3D models for your planning
	Media Browser	Store objects and files in the local directory system/insert into the planning
	Layer dialog	Control the visibility of objects on layers for view windows and overall planning
	Material Editor	Create, edit and manage materials
	Render Styles	Create individual display styles for real-time view
	Geometry Dialog	Settings for displaying various 3D objects

Über den Button *Anpassen* im Anwendungsmenü können Sie eine weitere Symbolleiste mit Funktionen bestücken und an die *Toolbar* andocken.

Working with mouse and keyboard

Mouse	
Left mouse button	<ul style="list-style-type: none"> Navigate, start and control functions and tools
Right mouse button	<ul style="list-style-type: none"> Click on the ribbon bar or quick launch bar: Opens menu for customizing the quick start Click on active workspace: Opens context menu Right mouse button pressed in the workspace: Navigation in PAN mode  Pan
Scroll Wheel	<ul style="list-style-type: none"> Pressing the scroll wheel: Navigation in Orbit mode Turning the scroll wheel: Zooming in and out 

Keyboard	
Enter Values	<ul style="list-style-type: none"> Draw walls, drawing elements etc.: Specify lengths and angles Tab key: Switch between different dimensions Enter key: Confirm entered value
Change unit of measurement	<ul style="list-style-type: none"> Enter an alternative unit of measurement after the value; confirm with Enter
Using Operators	<ul style="list-style-type: none"> Use operators such as +, - or / to make changes in relation to the current value Example: Wall is 5m long → Enter +2m instead of length = wall length 7m

Esc	<ul style="list-style-type: none"> • Cancel current action • Exit current navigation mode • Cancel current selection
Strg	<ul style="list-style-type: none"> • Select multiple objects • Copy an object (while moving) • Moving the wall snap point (while drawing walls)
Alt	<ul style="list-style-type: none"> • Change wall end point • Create reference copy (while moving)
W, A, S, D	<ul style="list-style-type: none"> • Moving in perspective
Shift + Space Key	<ul style="list-style-type: none"> • Zoom to the selected object(s)
Ctrl + Space Key	<ul style="list-style-type: none"> • Show all objects in the current workspace
Shift + Ctrl + Space Key	<ul style="list-style-type: none"> • Show all objects in all workspaces
Shift + Zoom	<ul style="list-style-type: none"> • Zoom through obstacles

Helpful Links

You can find the current system requirements for pCon.planner at: [pCon.planner_7_System-Requirements.pdf \(pcon-planner.com\)](#)

Questions about operation or technical problems? You can find detailed online help for pCon.planner at <https://help.pcon-planner.com/en/help/>

Under the menu item Questions & Answers ([Questions & Answers | pCon.planner Help Center \(pcon-planner.com\)](#)) we also answer frequently asked user questions about printing, graphics, hardware, etc.

Tips & Tricks for pCon.planner - Extensive collection of videos on presentation, planning and productivity: [pCon - YouTube](#)

2. Working Areas and Presentation

Open the **Operating Room** file. Set the display of the workspaces as shown in the image below. Assign the following views and display modes to the workspaces:

1. Rear view - *color* display mode
2. Right view - *wireframe* display mode
3. Top view – *hidden line* display mode
4. Perspective view - *realistic* display mode

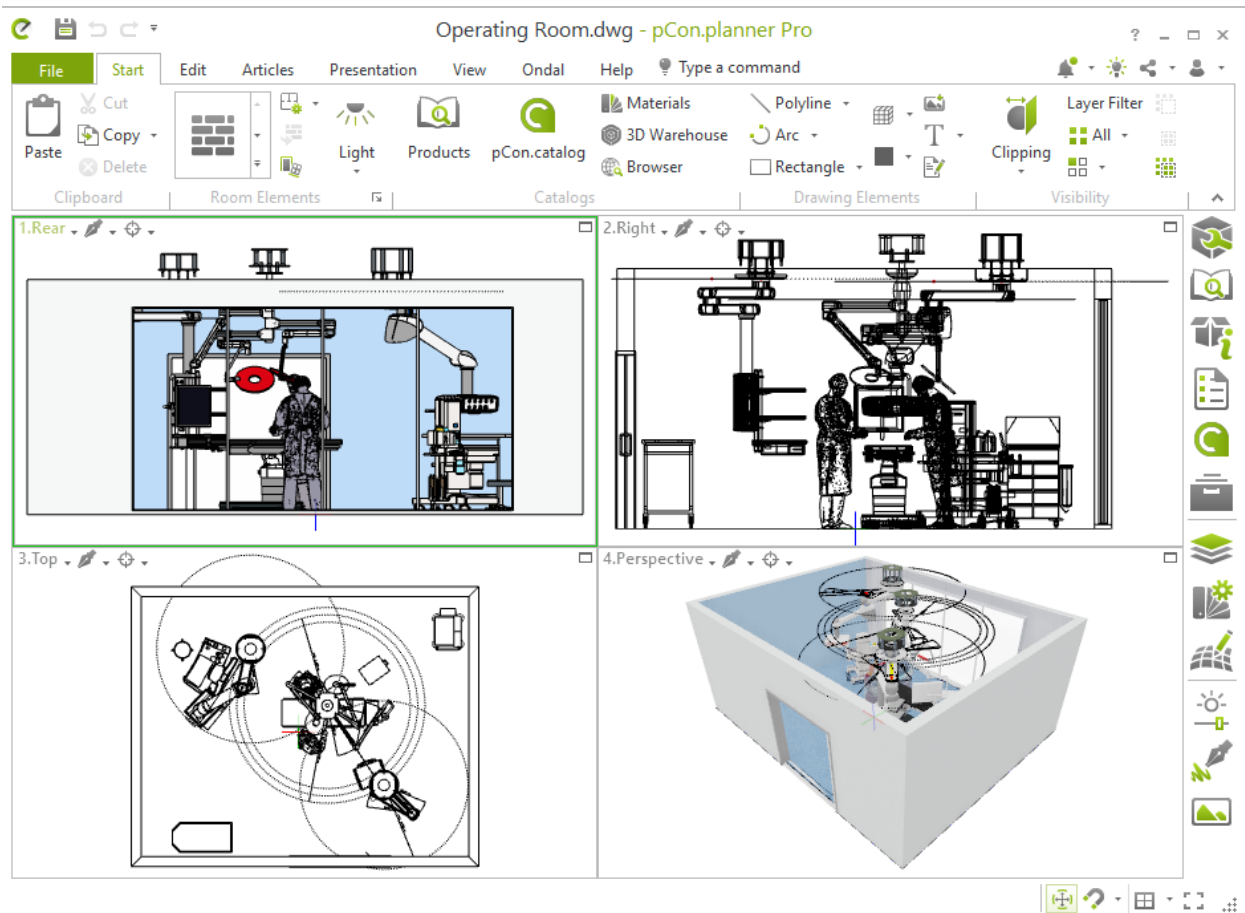

A different view or display mode is suitable for each work step. For example, we recommend the top view for drawing walls or inserting objects. The *perspective*, combined with the *Illuminated* or *Realistic* display modes, gives you an overall impression of your planning.

3. Navigation

Open the file **Operating Room**. Navigate to a similar view in your open planning. Test the various navigation instruments - *pan, orbit, zoom, look around* and *walk*.

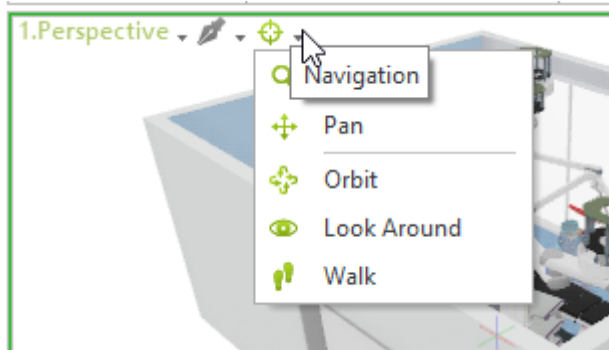

For a better overview when creating, editing and presenting a plan, selections can be shown or hidden. The Visibility group (Start tab) offers the *Hide selection, Hide others* and *Show all buttons* for this purpose. All changes that you make in a plan only affect the visible elements. Hidden objects are excluded from changes.

4. View

In the "View" tab on the right-hand side of the Camera group, you can select various predefined views to focus on the selected object in your planning.

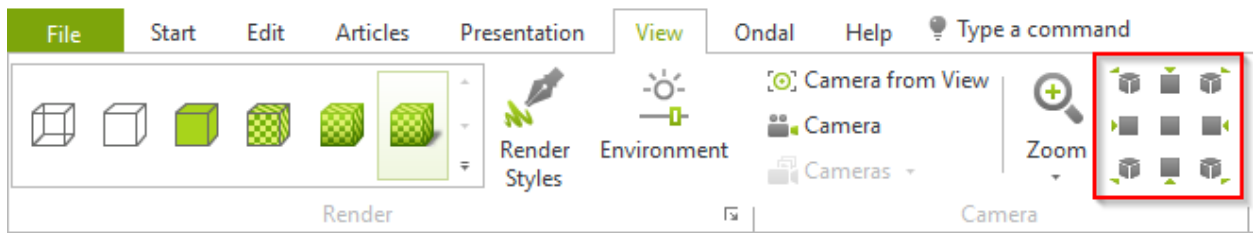

Here are examples of the "Zoom front" and "Zoom left" view:

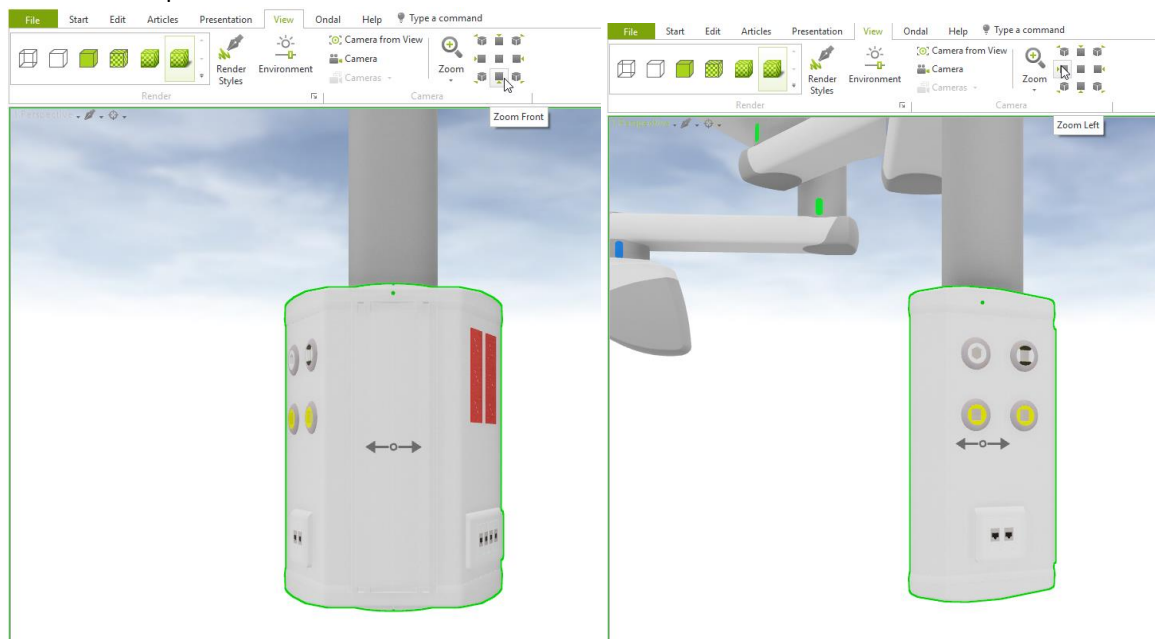

5. Inserting and configuring Ondal products

Open a new project via *File* and *New*. Call up *Products* in the Catalogs tab to integrate Ondal products into your planning.

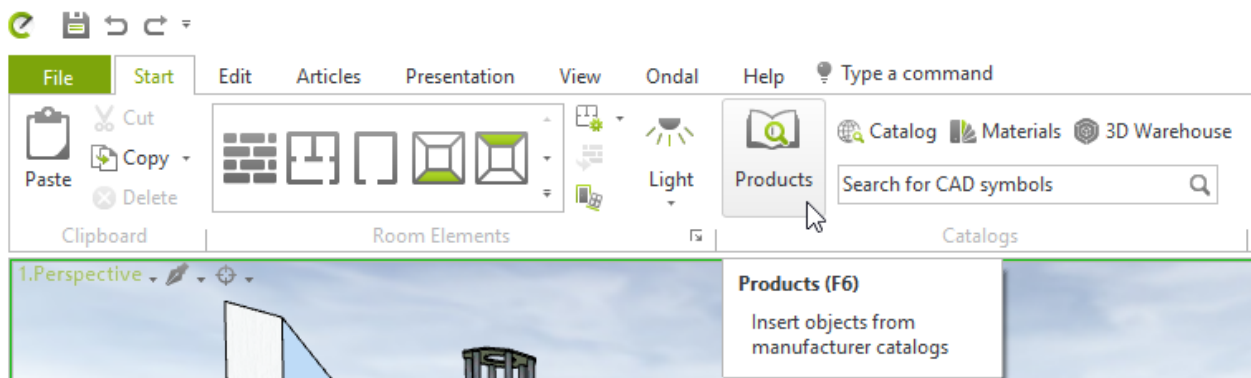

Click on the "Ondal Medical Systems" catalog.

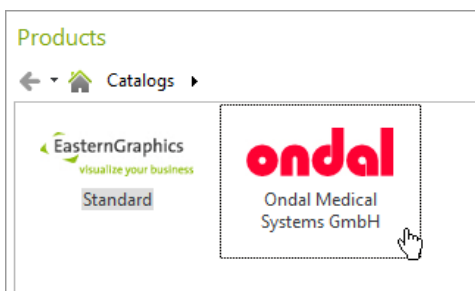

You can now insert various Ondal systems into an empty configuration or select "Empty room" in advance. Here we have already created a room with walls and floor.

Select *ceiling supply units* or *Pendant systems for OR lights and monitors* in the Ondal catalog. You will also find various 3D models of operating tables, anesthesia machines and in the catalog under *Other medical equipment*, and several 3D models of doctors in *Medical Staff*.



Place the selected system at the desired position in the configuration/ in the room already drawn. This best view to do this is the *Top* view.

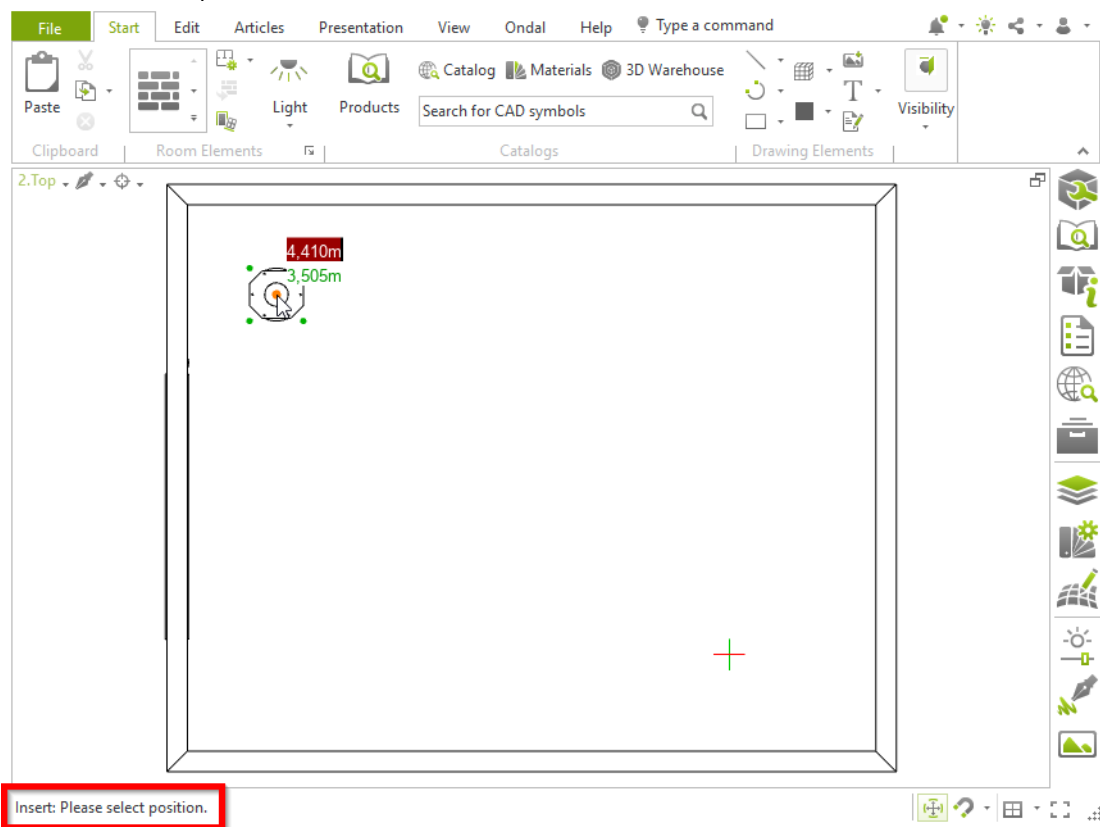

Then select the desired rotation. With Ondal systems, only the ceiling frame is inserted first. It is therefore not necessary to define the rotation here and can simply be carried out with a click. If you are importing an operating table, for example, it makes sense to first define the position and then the rotation.

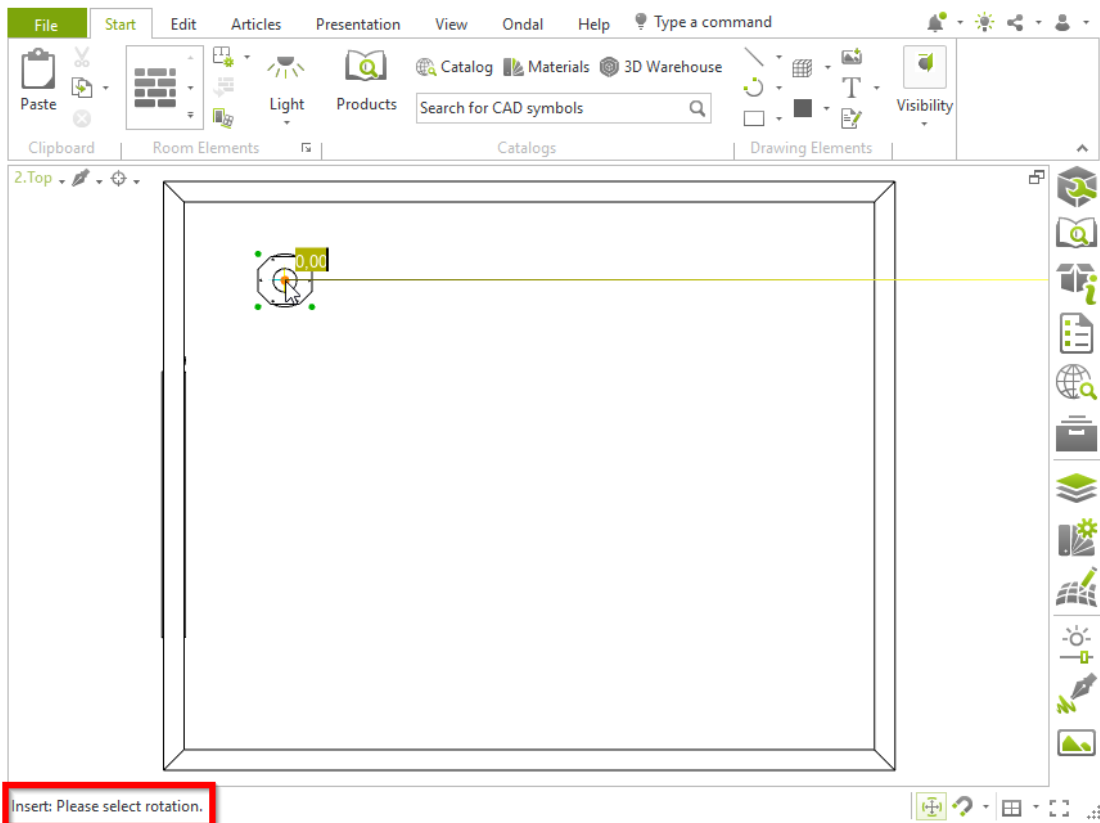

Once you have selected the position, the properties field appears on the right-hand side where you can make your further selection. It is important that the system to be configured is selected, which is indicated by the colored marking.

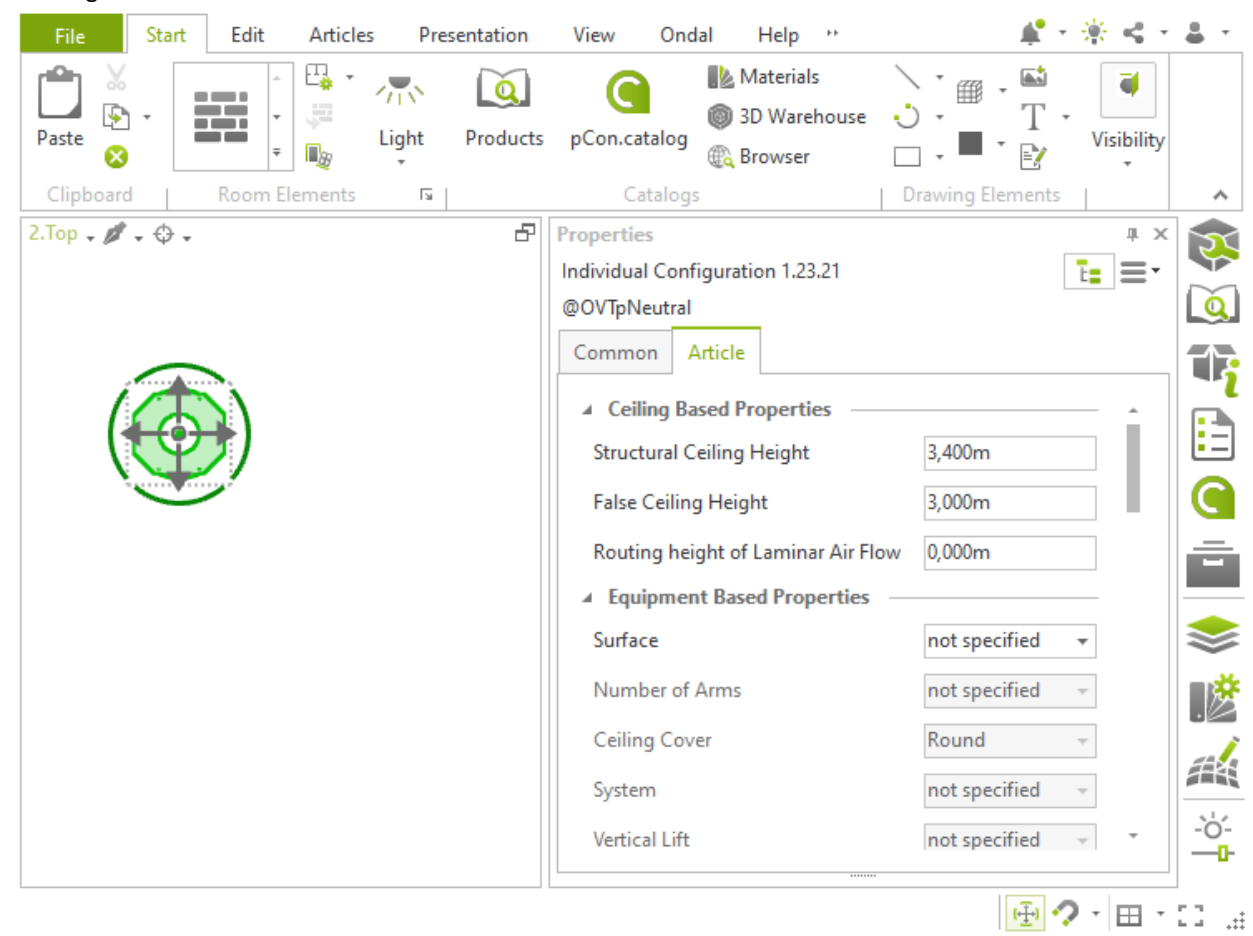

For further configuration, it makes sense to switch to a different view. We select the *Perspective* view here. The system can now be configured in the properties field on the right.

We start with general parameters for the room height, surface and properties of the support arm system (braking system, reach, etc.). Double-click to select the Service Head or other components (drop tube, Multi Function Rack (MFR), shelf) to configure them in detail. The respective selection options for the selected component appear in the properties field on the right-hand side.

Finally, you must optimize the service head. In the last step, select the complete configuration again and click on *Start* in the properties of the system configuration under *Check configuration*. The system will now check whether all information has been entered and all rules have been adhered to. If not, you will receive further messages; if yes, you will receive a message that the configuration is correct.

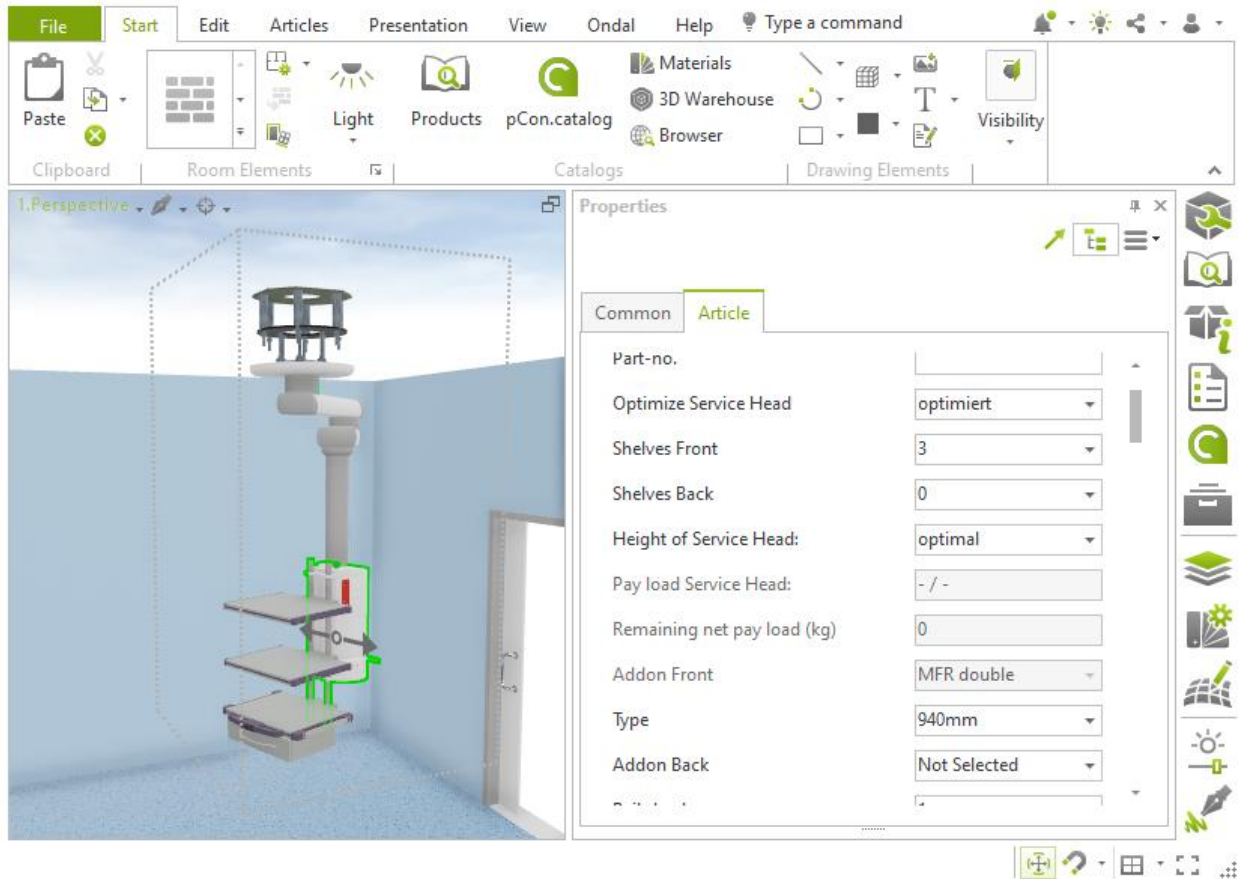

Change positions of Gas Outlets

The different gas outlets are arranged in the pCon.planner in accordance with Health Technical Memorandum 02 (HTM 02). If different positions of different gas outlets are required, you have the option of swapping gas outlets. This is done as follows: First select the outlet. Then an interactor with a double arrow appears there. If you click on this, the outlet is colored red (and a message appears at the bottom right). The second outlet can now be selected. This will then trigger the exchange.



Importing additional objects

In addition to Ondal products, you will find other equipment elements in Sketchup's *3D Warehouse*. For example, you can search for furniture for operating room equipment or an intensive care unit - and use it for your planning. All you have to do is register with Trimble free of charge.

This video explains the details: [How to import 3D Warehouse models into pCon.planner - YouTube](#)

6. Selecting, moving and rotating objects

Individual selection by mouse click

An object is selected using its edges and faces. These are simply clicked on with the mouse.

Multiselection by mouse click

If you want to select several objects one after the other, press the *Ctrl* key and hold it down while selecting objects. This procedure allows you to select any number of objects in a plan.

Press *Ctrl + M* to select the next higher product level (e.g. if a shelf is selected, press *Ctrl + M* to select the Service Head and *Ctrl + M* again to select the complete supply unit including pendant).

Selection via selection area

To select several objects at the same time, you can draw a selection area. To do this, left-click in the work area and hold down the mouse button while dragging the selection area with the mouse pointer. Depending on where you start dragging this area from, it will be highlighted in red or green.

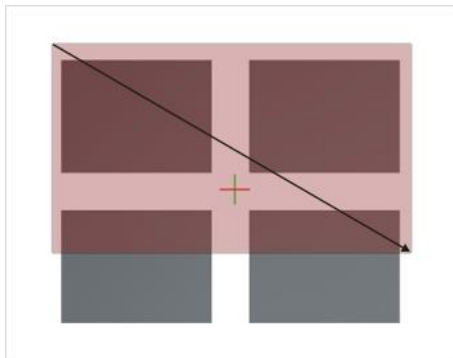

If you start from the left and drag the area to the right, it will be highlighted in red. All objects that are completely enclosed by the red area are selected when you release the mouse button. In the image example: The two upper rectangles are selected.

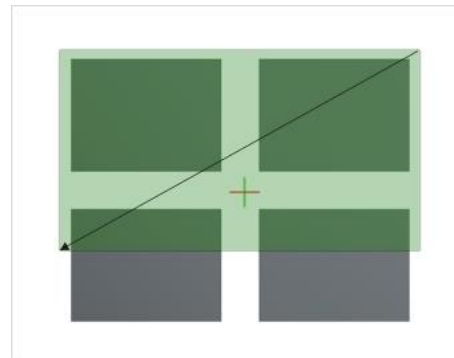

If, on the other hand, you drag the selection area from right to left, a green marking is created. All objects that are intersected by the green area are selected when you release the mouse button. In the example image: All four rectangles are selected.

Move and rotate objects

Test moving and rotating with the object interactor. This is displayed after selecting an object. Briefly click on the arcs to rotate your object. Use the arrows to move it in the desired direction. The object interactor always adapts to the freedom of movement of the selected object. It is recommended that you never move objects in perspective, but always in the view from above, as only two dimensions come into play here and you cannot accidentally move the object in height. In addition, the wireframe view should be preferred when moving objects, as otherwise the floor could be moved inadvertently.

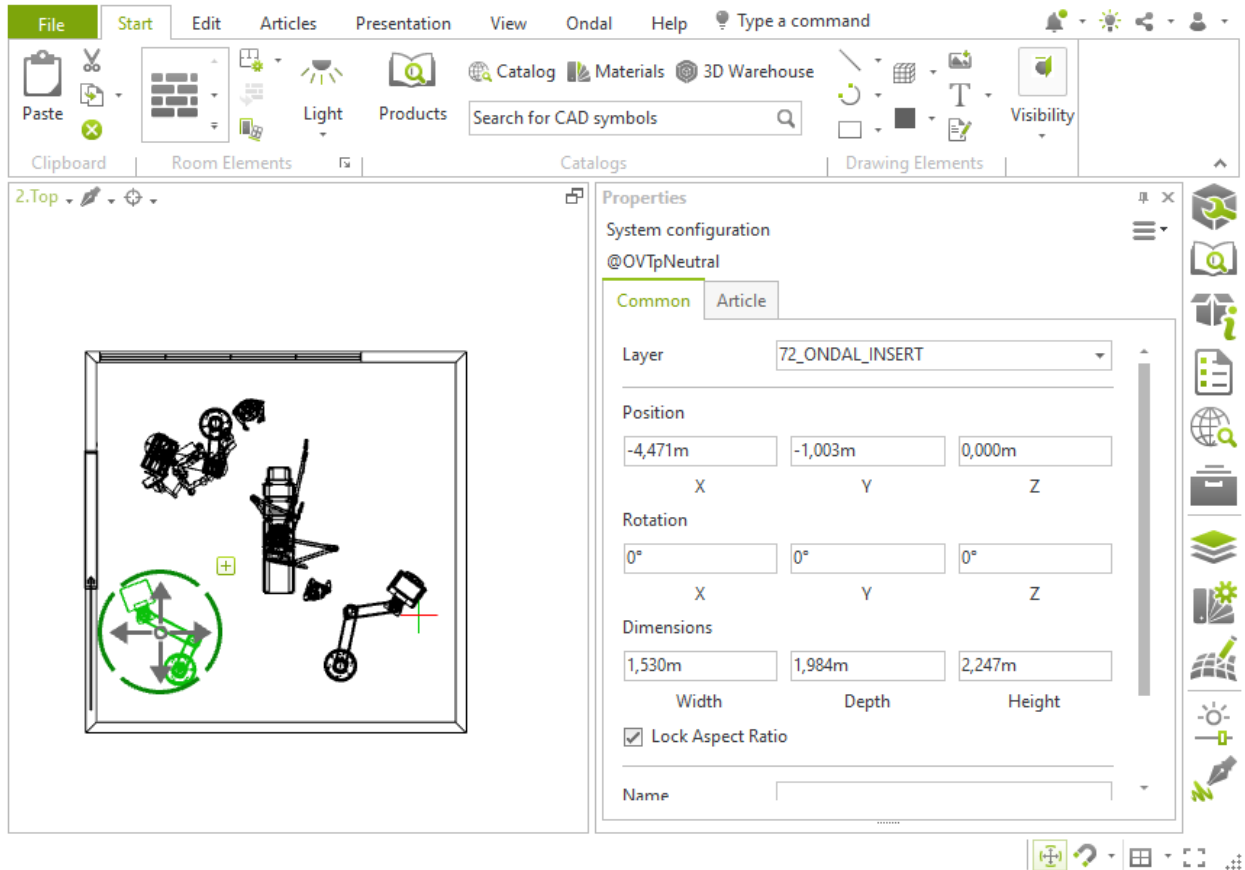

If you want to change the angle of the Ondal arms to each other or the height of the vertically adjustable arms, you must select the individual elements of the support arm system (lower arm, Service Head, shelf, spring arm) by double-clicking on them so that they are highlighted. The object interactor then appears and shows you the possible movement options for this view.

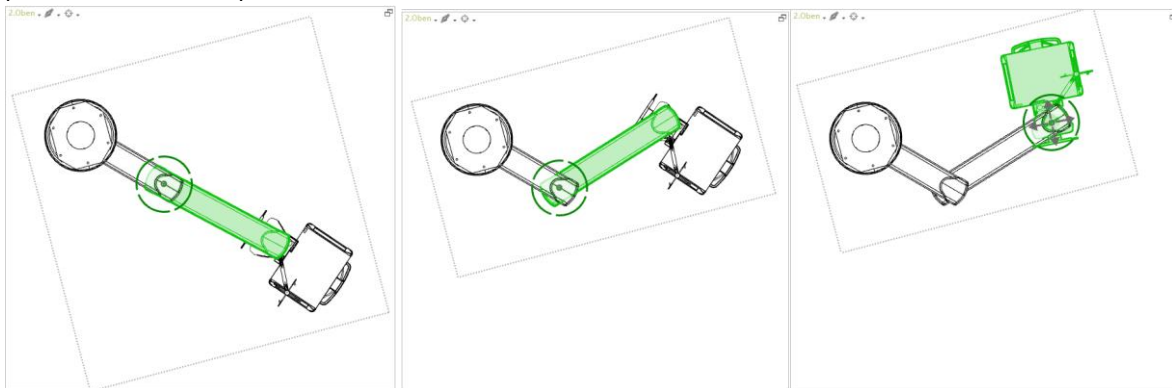

Please note that a shelf marked alone can only be moved up and down without the Service Head. For this reason, the object interactor in the *top view* does not display any movement options for the shelf. As soon as you select the shelf in the *perspective view*, you can move it in height on the MFR.

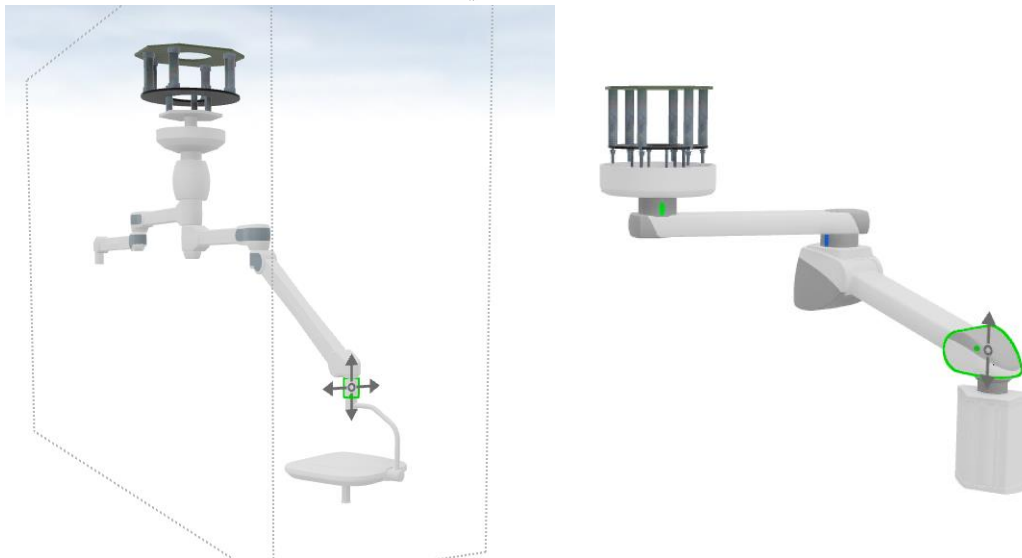
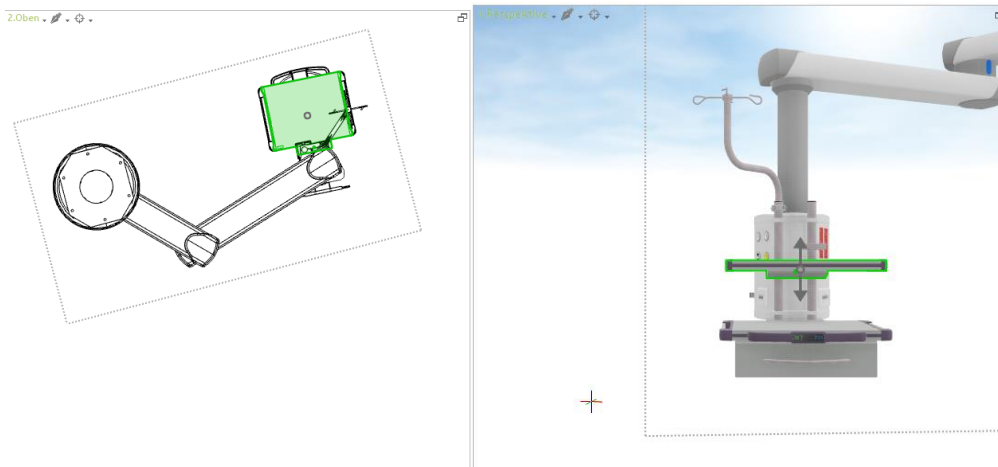

If you click on the small circle in the center of the object interactor, you can move the system freely and perform an up/down movement and simultaneous rotation.

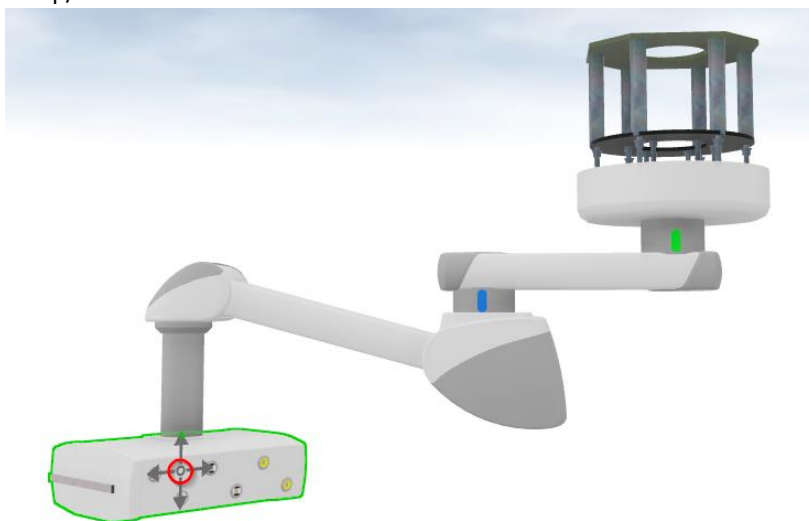

7. Project Information and Drawing Templates

Project information such as project name, project room, project number or country can be entered in the document properties. This data is then also transferred to the drawing stamps. To do this, the drawing template (*Ondal_DE_EN*) must be saved once in the settings in pCon.planner:

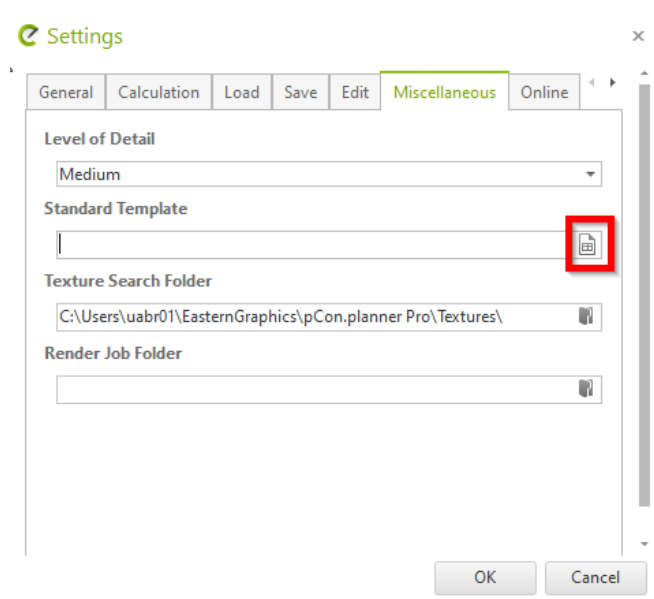
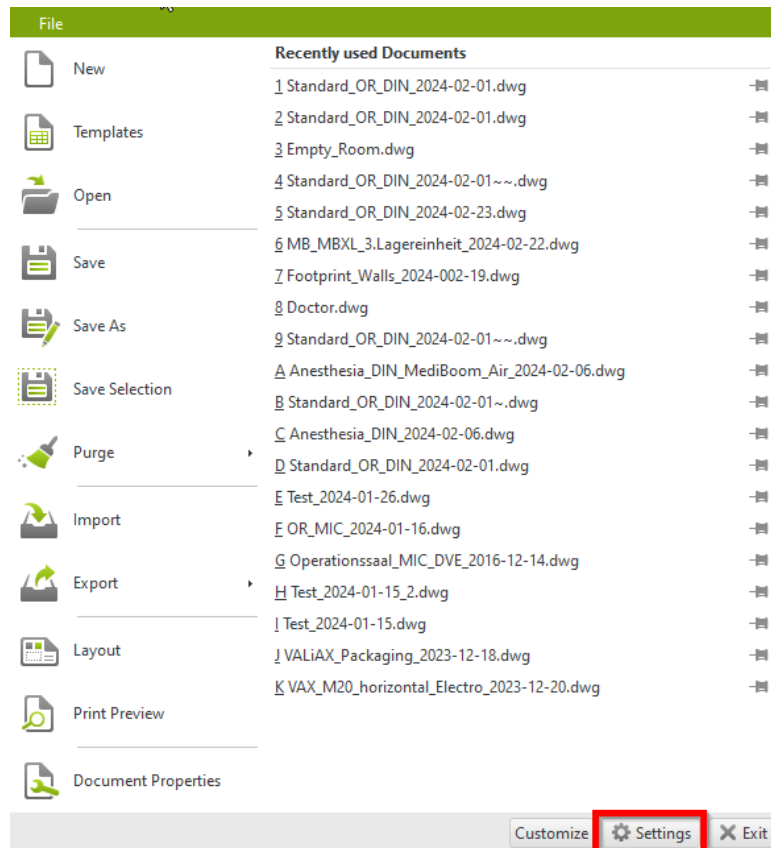

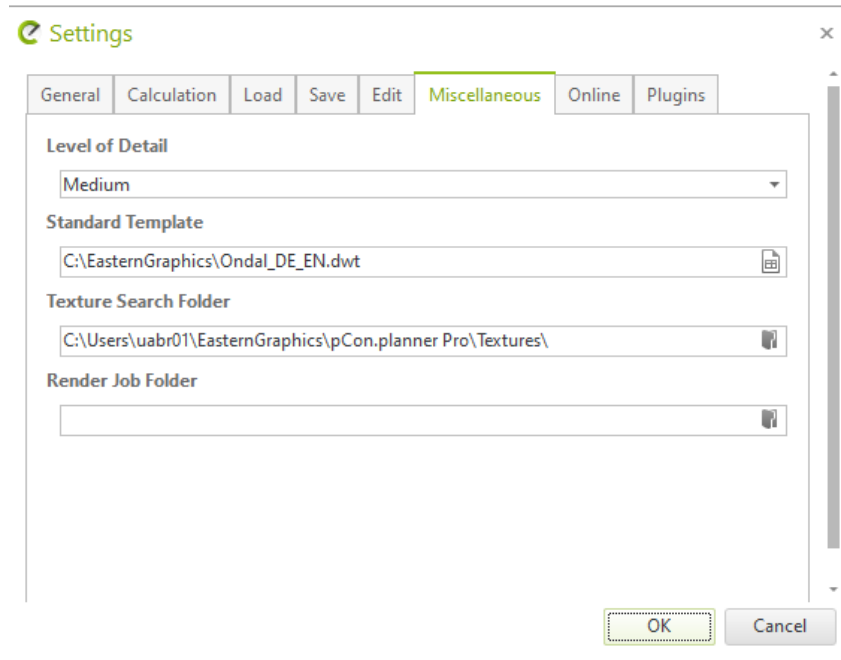

The corresponding fields are then stored in the document properties for each new project and can be filled in.

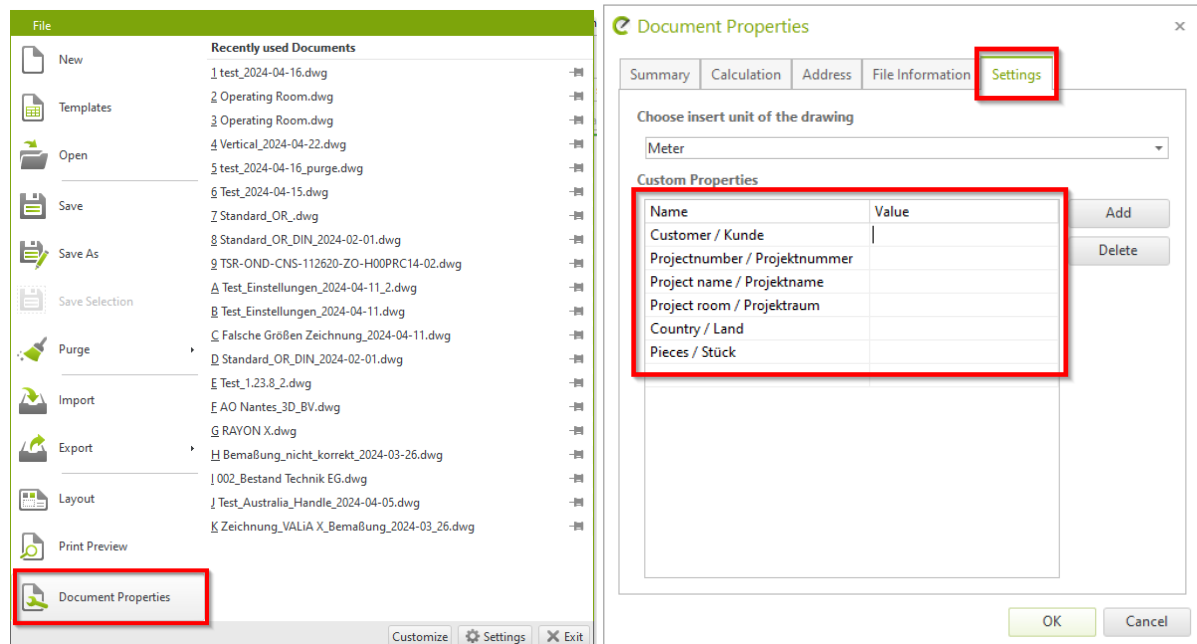

8. Create and Export Drawings

To create drawings of the configured systems, first select a configuration/ Ondal system by highlighting it. Then go to the *Ondal* tab and then to *Layout Creator*.

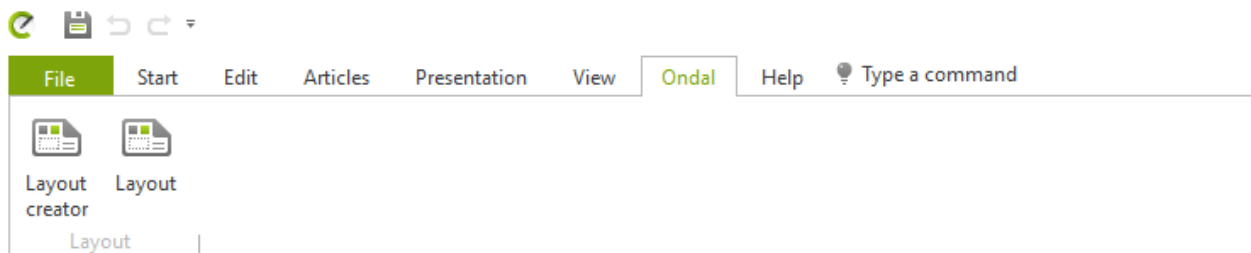
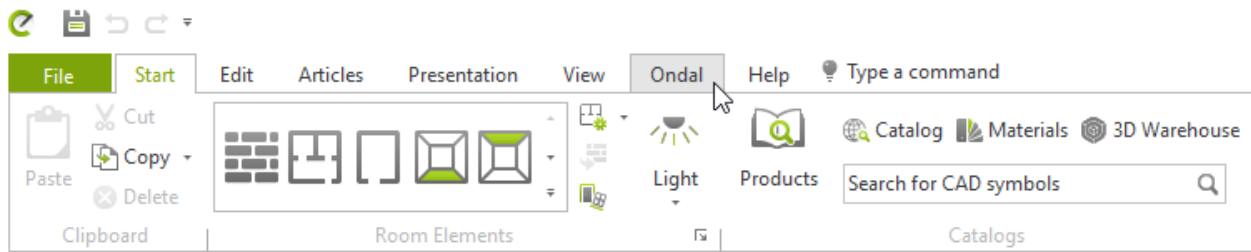

A window opens in which you can select the various drawings. You can select the language and if you like to create one or more drawing variants by holding down the *Shift* key.

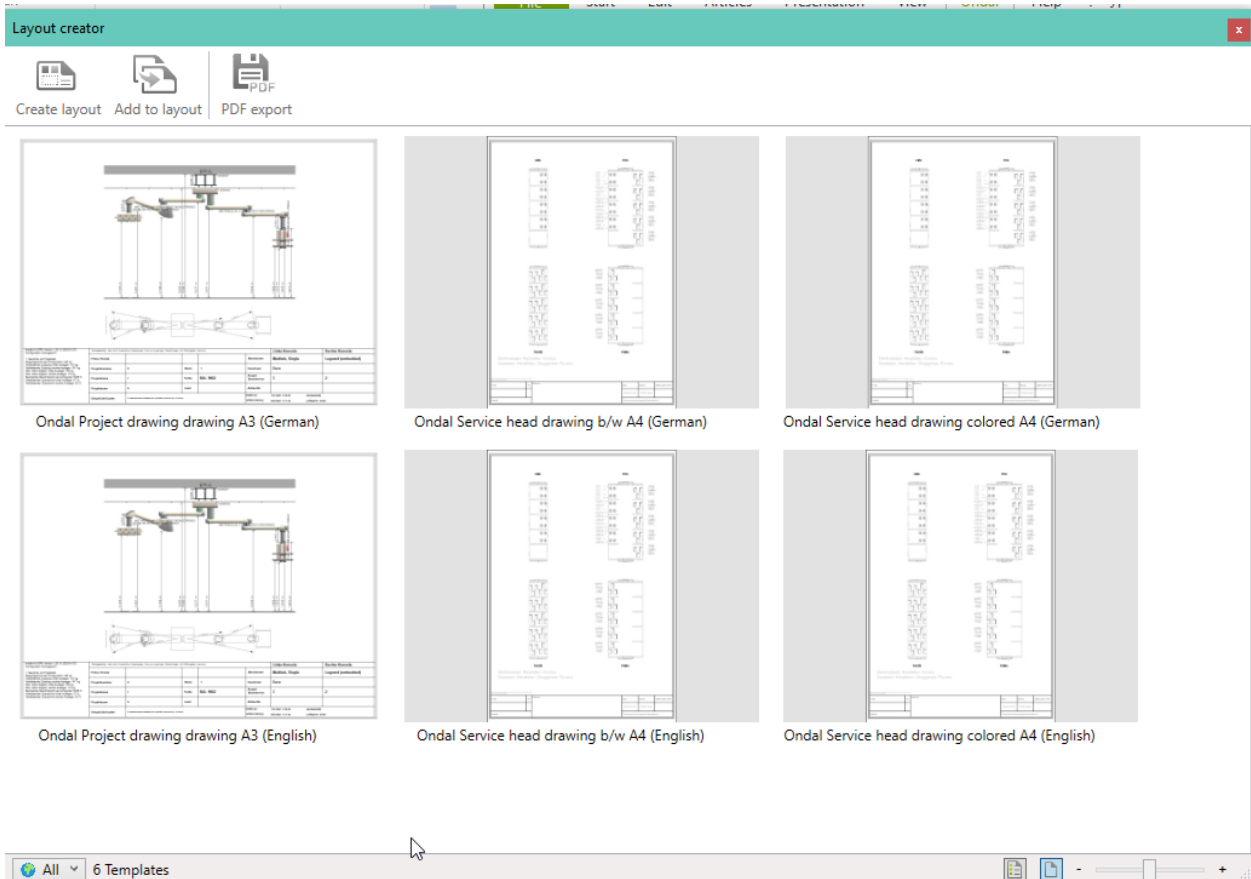

If you want to return to configuration in planning mode, click on *Exit layout* on the far right.

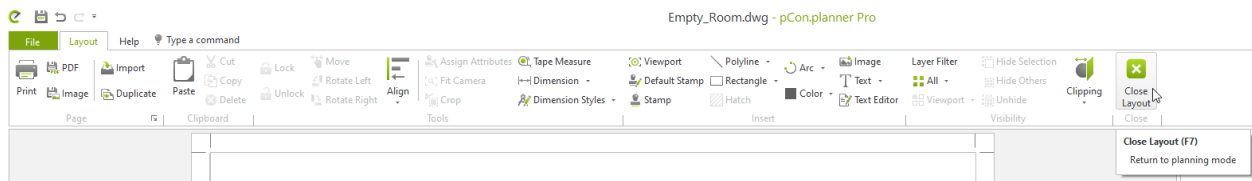

Layouts that have already been created can be called up via the *Layout* button.

If you are planning several configurations in one project, you can now mark the next configuration, select the corresponding drawings and **add** them to the layout.

ATTENTION: If you click on *Create layout* again, the previously created layout will be deleted. Please use the function *Add to layout*.

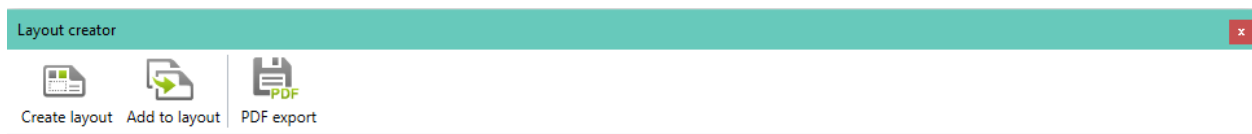

You can also create your own layouts for your project. To do this, you can insert additional pages by clicking on *Create a new page* in the area below the drawings.

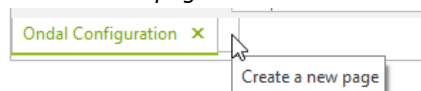

In addition to the standard project and Service Head drawings, you can insert various elements such as text, images or viewports from the 3D configuration on a blank page to provide a clear overview of the entire configuration/room or to highlight certain objects/views. You can select these options in the *Insert* section. You can edit the desired section of the viewports from the 3D configuration individually using the properties editor. You can also zoom in or out and move selected objects within the viewports to obtain the desired view.

We also recommend these videos for this purpose:

[Layout Area Part 1 | pCon.planner Tutorial \(youtube.com\)](#)

[Layout Area Part 2 | pCon.planner Tutorial - YouTube](#)

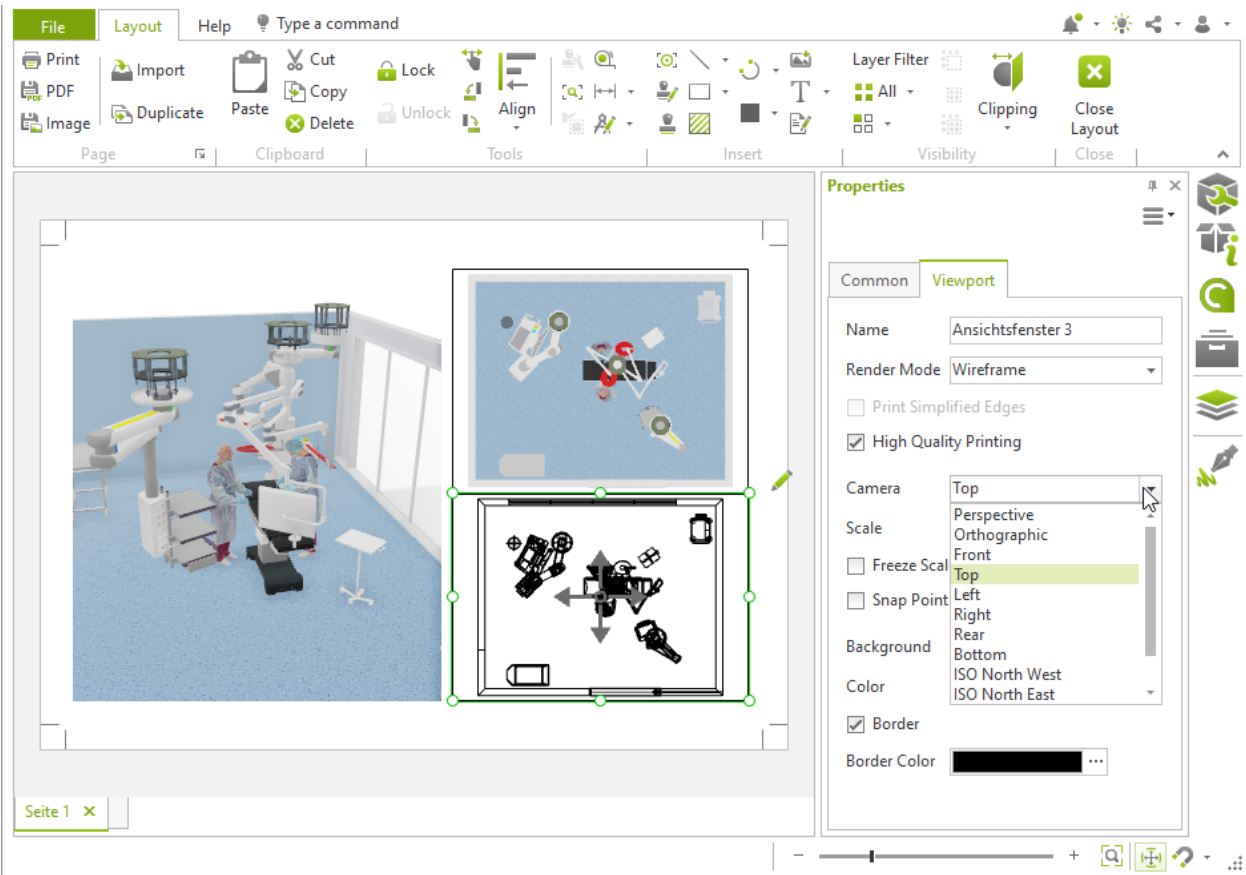
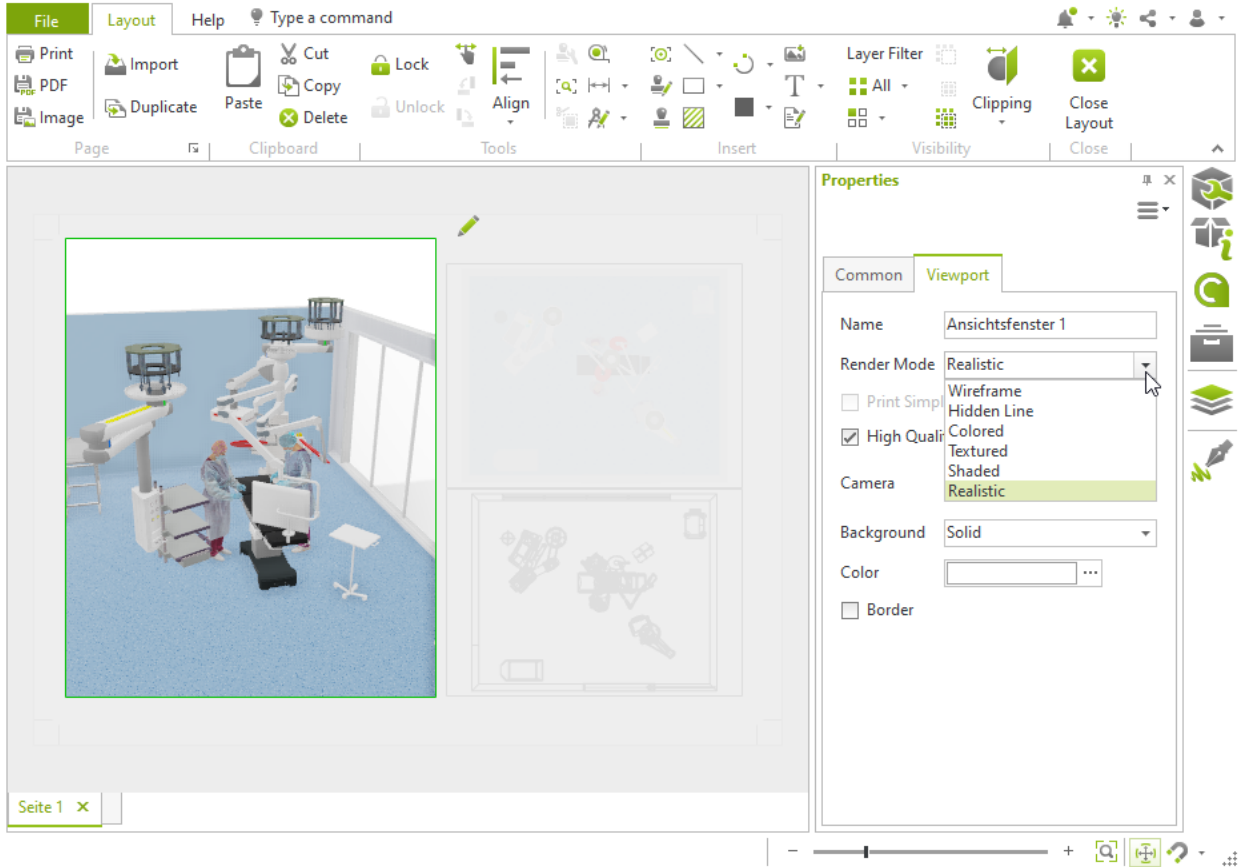

9. Export Article List as Excel Table

You can export the article list to a Microsoft Excel file as follows: Open the application menu and select Export. Select the Article option. In the export dialog that opens, select File type: Microsoft Excel, enter the storage location and file name and confirm with Save. This opens the Article export options dialog. Here you have the same setting options as when creating an article list. Make your settings for hierarchies, selection, manufacturer etc. and confirm with Export. We recommend setting your selection like shown in the screenshot below.

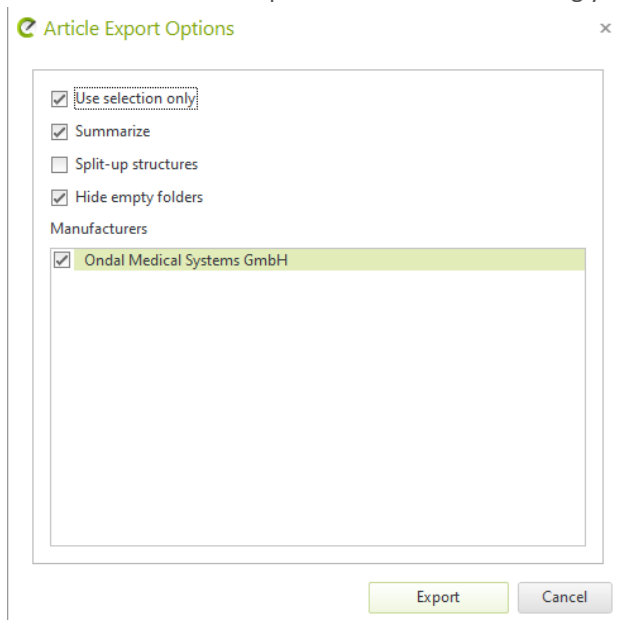

10. Drawings of Walls

Draw a square room with the following internal dimensions:

- Length: 15.00m
- Width: 10.00m
- Height of walls: 2.60m
- Thickness of walls: 0.20m

Two individual walls can be joined together using the *Join* command, *Start tab, Room elements* group.

11. Insert Room and Wall Elements

Plan wall elements

Continue working on your room. It will now have a door, two windows and a glass front. Use the dimensions from the floor plan shown below.

- Height of the door: 2.30m
- Skylight height: 0.30m
- Type of window: Double window
- Window height: 1.60m
- Window sill height: 0.80m
- Number of glass front segments: 8
- Height of the glass front: 1.80m
- Parapet height of glass front: 0.80m

You will find the room settings in the *Start tab, Room elements* group. In this dialog, you predefine dimensions for walls, windows and doors.

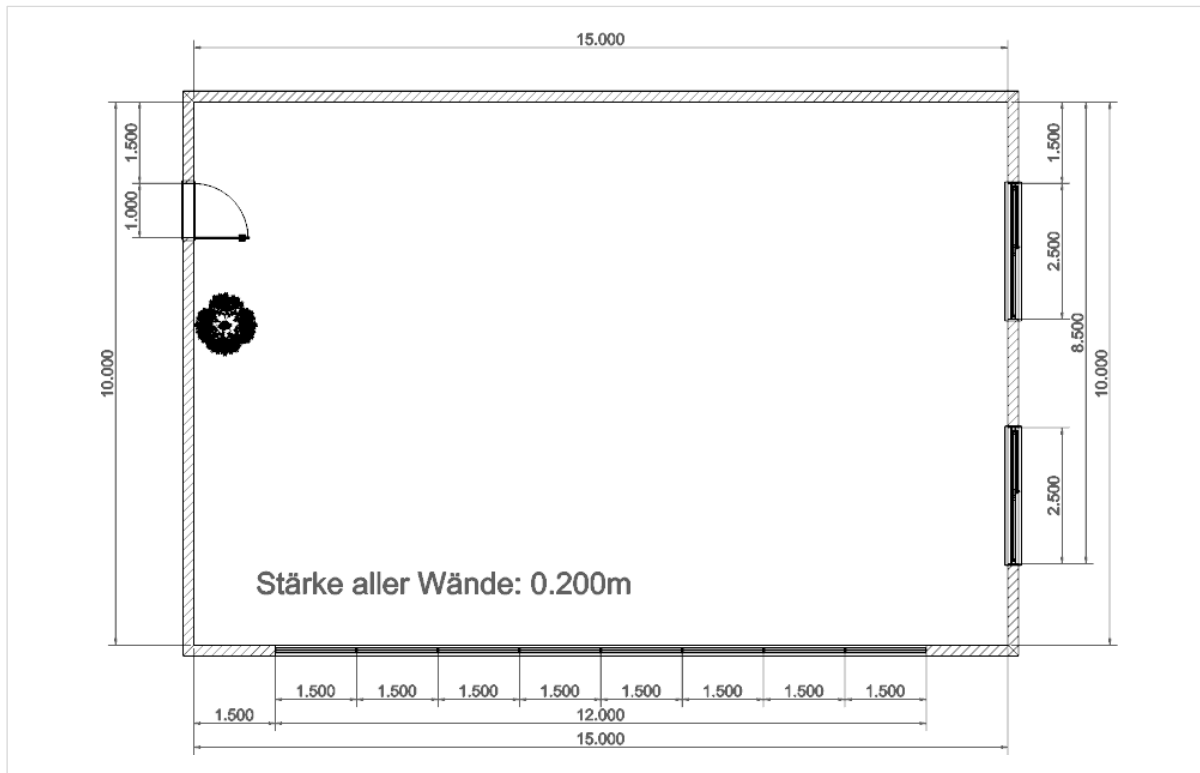

Do you want to edit the properties of your wall elements and change the number of sections of a glass front, for example? Take a look at the property editor.

Extend Floor Plan

Now draw two more partition walls in the floor plan. Use the center of the outer walls as the starting point. Details in the picture:

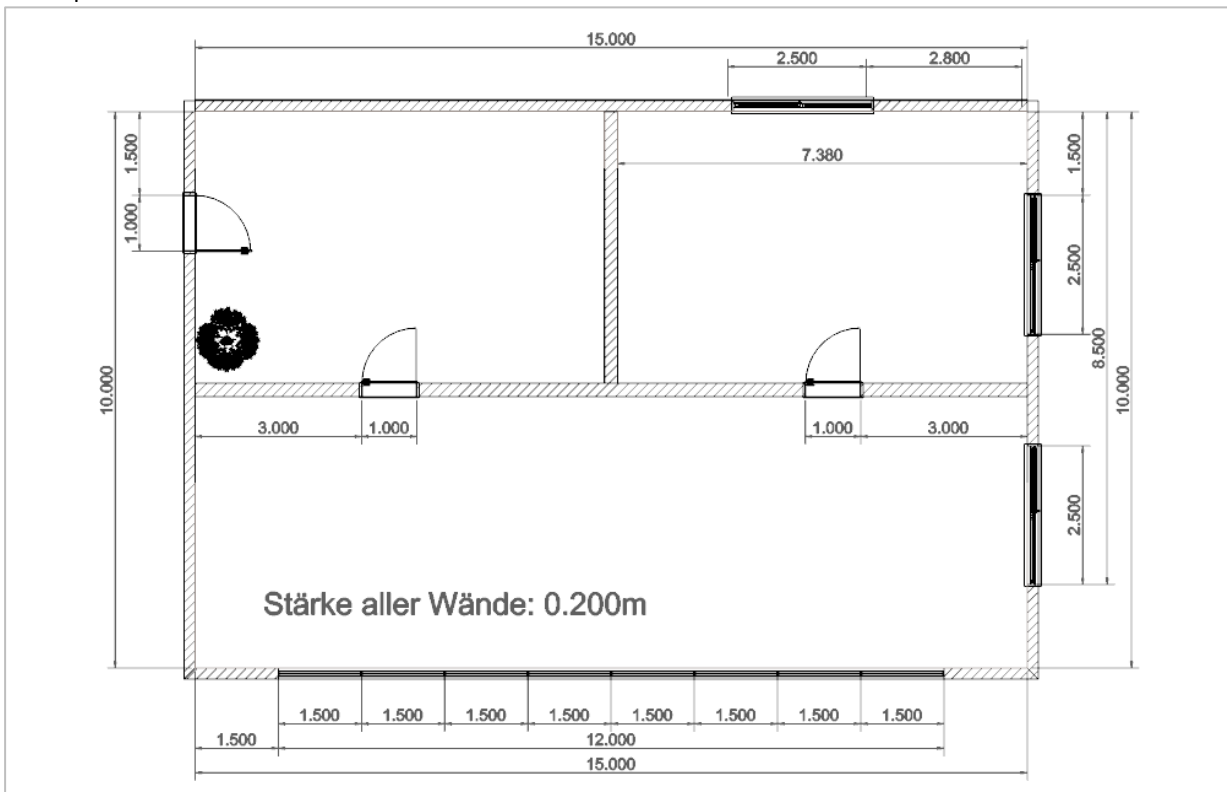

You can turn one wall into two using the Split wall command, Start tab, Room elements group. This allows you to split walls at the transition to a new room, for example, so that you can later edit the room wall separately or assign it its own texture.

Draw Floor and Ceiling

The room is now missing the floor and ceiling. Add both.

Do you need a grid ceiling? You can change the type of your ceiling using the property editor. To prevent a room ceiling from making your further planning work more difficult, hide it. To do this, select the ceiling and click Hide selection in the Start tab, Visibility group.

Dimension floor plan

Dimension your floor plan as shown in the second image (section *Extend Floor Plan*).

12. Import and Edit Footprint

In pCon.planner, you can import floor plans in PDF format, which you can then trace with the floor plan tool and insert walls and other elements.

This video shows you the basics of using floor plans in pCon.planner. You will learn how to import, scale and cut PDF floor plans correctly:

[Quickly import, scale and crop PDF floor plans | pCon.planner Tutorial - YouTube](#)

In this video you will see some tricks that you should keep in mind when tracing floor plans in pCon.planner:

[How to draw WALLS on FLOOR PLANS | pCon.planner Tutorial \(youtube.com\)](#)

13. Render Images and Animations

At [pCon.planner 8 online help \(pcon-planner.com\)](#) under *Presentation* you will find instructions on how to create media in pCon.planner. Here you can find out how to create individual images or panoramas. The creation of animations and their further processing into videos is also explained here. unter *Präsentation* finden Sie Anleitungen zum Erstellen von Medien im pCon.planner. Hier erfahren Sie, wie Sie Einzelbilder oder Panoramen erstellen. Auch das Anlegen von Animationen und ihre Weiterverarbeitung zu Videos finden Sie hier erklärt.

[Rendering single frames | pCon.planner Tutorial - YouTube](#)

[How to create animations | pCon.planner Tutorial \(youtube.com\)](#)

14. Share Content

Share 3D models for quick viewing on your mobile device. No special software is required for this.

You can also watch this helpful video: [Share AR content | pCon.planner Tutorial - YouTube](#)

 <p><i>Live View</i></p>	<p>Present your planning in a separate view window, which can be moved independently of the pCon.planner user interface. Place the Live View on a second monitor or share it in an online meeting.</p>
 <p><i>Augmented Reality (AR)</i></p>	<p>Use this feature to export your planning to the export formats for augmented reality. You transfer the export files to your (AR-capable) smartphone. AR files can be sent or linked in a presentation.</p>
 <p><i>Share of CAD models</i></p>	<p>Mark objects or your complete planning and share it with third parties via Impress to display them on your desktop, tablet or smartphone. Connection to a cloud service is required. Or you can use the integrated cloud service provider (max. file size per upload 1GiB, total size of uploads per IP in 24 hours: 10GiB, total size of all active uploads from pCon.planner: 1TiB, duration of availability of uploads: 30 days)</p> <div data-bbox="483 1541 1070 1933" style="border: 1px solid #ccc; padding: 10px; margin: 10px 0;">  </div> <p>https://impress.pcon-solutions.com/?l=en&embed=https%3A%2F%2Fondalmedicalsystems-my.sharepoint.com%2F%3A%3A%2Fpersonal%2Fuabr01_ondal_com%2FETjH3rUiglpCuojl7Q u8pEYBVUmzSIC42YOucs2a3eRBHQ</p>

	<p><i>Vector graphic</i></p>	<p>Calculate vector graphics from the current planning view.</p>
-----------------------------------------------------------------------------------	------------------------------	------------------------------------------------------------------

15. Export

A detailed list of the file formats supported by pCon.planner for loading/importing and saving/exporting can be found here: [pCon.planner 8 online help \(pcon-planner.com\)](http://pcon-planner.com)

If you only want to share the geometry of a project and not the commercial data like prices - for an architect, for example - it is advisable to export the desired selection as geometry and then in the next window click on *Remove article information* in the *Change* tab.

